

DISCOUNT CODES	
01	Schedule 40 through 8"
91	Schedule 40 10" and larger
96	Class 125
09	Pool and Spa
14	LASCOtite Compression Fittings
14	Slip Fix

PVC - White Pressure Fittings

Includes:

- **Schedule 40** - through 8"
- **Schedule 40** - 10" and larger
- **Class 125**
- **Pool and Spa**
- **LASCOtite** - Compression Fittings
- **Slip Fix**

List Prices

Effective:

September 26, 2010

Schedule 40

	PART NO.	SIZE	CARTON	CODE	PRICE
		(IN.)	(QTY.)		(EA.)
	Tee				
 (slip x slip x slip)	401-003	3/8	100	01	2.36
	401-005	1/2	50	01	0.76
	401-007	3/4	50	01	0.87
	401-010	1	50	01	1.63
	401-012	1 1/4	25	01	2.55
	401-015	1 1/2	25	01	3.10
	401-020	2	25	01	4.51
	401-025	2 1/2	10	01	14.89
	401-030	3	10	01	19.56
	401-040	4	5	01	35.39
	401-050	5	4	01	85.45
	401-060	6	4	01	119.10
	401-080	8	2	01	276.22

	PART NO.	SIZE	CARTON	CODE	PRICE
		(IN.)	(QTY.)		(EA.)
	Tee Reducing				
 (slip x slip x slip)	401-094	3/4 x 1/2 x 1/2	50	01	1.47
	401-095	3/4 x 1/2 x 3/4	50	01	1.47
	401-101	3/4 x 3/4 x 1/2	50	01	1.01
	401-122	1 x 1/2 x 1	50	01	2.89
	401-124	1 x 3/4 x 1/2	50	01	2.89
	401-125	1 x 3/4 x 3/4	50	01	2.89
	401-126	1 x 3/4 x 1	50	01	2.89
	401-130	1 x 1 x 1/2	50	01	1.72
	401-131	1 x 1 x 3/4	50	01	1.88
	401-156	1 1/4 x 1 x 1/2	25	01	3.95
	401-157	1 1/4 x 1 x 3/4	25	01	3.95
	401-158	1 1/4 x 1 x 1	25	01	3.95
	401-166	1 1/4 x 1 1/4 x 1/2	25	01	2.80
	401-167	1 1/4 x 1 1/4 x 3/4	25	01	2.80
	401-168	1 1/4 x 1 1/4 x 1	25	01	2.80
	401-199	1 1/2 x 1 1/4 x 1/2	25	01	4.91
	401-201	1 1/2 x 1 1/4 x 3/4	25	01	4.91
	401-202	1 1/2 x 1 1/4 x 1	25	01	4.91
	401-203	1 1/2 x 1 1/4 x 1 1/4	25	01	4.91
	401-209	1 1/2 x 1 1/2 x 1/2	25	01	4.91
	401-210	1 1/2 x 1 1/2 x 3/4	25	01	4.91
	401-211	1 1/2 x 1 1/2 x 1	25	01	4.91
	401-212	1 1/2 x 1 1/2 x 1 1/4	25	01	4.91
	401-238	2 x 1 1/2 x 3/4	10	01	7.02
	401-239	2 x 1 1/2 x 1	10	01	7.02
	401-241	2 x 1 1/2 x 1 1/2	10	01	7.02
	401-247	2 x 2 x 1/2	10	01	4.83
	401-248	2 x 2 x 3/4	10	01	4.83
	401-249	2 x 2 x 1	10	01	4.83
	401-250	2 x 2 x 1 1/4	10	01	4.83
	401-251	2 x 2 x 1 1/2	10	01	4.83
	401-287	2 1/2 x 2 1/2 x 1/2	10	01	14.86
	401-288	2 1/2 x 2 1/2 x 3/4	10	01	14.86
	401-289	2 1/2 x 2 1/2 x 1	10	01	14.86
	401-290	2 1/2 x 2 1/2 x 1 1/4	10	01	14.86
	401-291	2 1/2 x 2 1/2 x 1 1/2	10	01	14.86
	401-292	2 1/2 x 2 1/2 x 2	10	01	14.86
	401-333	3 x 3 x 1/2	10	01	21.28
	401-334	3 x 3 x 3/4	10	01	21.28
	401-335	3 x 3 x 1	10	01	21.28
	401-336	3 x 3 x 1 1/4	10	01	21.28
	401-337	3 x 3 x 1 1/2	10	01	21.28
	401-338	3 x 3 x 2	10	01	21.24

	PART NO.	SIZE	CARTON	CODE	PRICE
		(IN.)	(QTY.)		(EA.)
	Tee Reducing (cont.)				
 (slip x slip x slip)	401-339	3 x 3 x 2 1/2	10	01	26.57
	401-416	4 x 4 x 3/4	4	01	35.39
	401-417	4 x 4 x 1	4	01	35.39
	401-418	4 x 4 x 1 1/4	5	01	35.39
	401-419	4 x 4 x 1 1/2	5	01	35.39
	401-420	4 x 4 x 2	5	01	35.39
	401-422	4 x 4 x 3	5	01	35.39
	401-486	5 x 5 x 2	5	01	82.97
	401-488	5 x 5 x 3	5	01	82.97
	401-490	5 x 5 x 4	5	01	82.97
	401-528	6 x 6 x 2	5	01	119.10
	401-530	6 x 6 x 3	5	01	119.10
	401-532	6 x 6 x 4	5	01	119.10
	401-582	8 x 8 x 4	2	01	276.22
	401-585	8 x 8 x 6	2	01	276.22

	PART NO.	SIZE	CARTON	CODE	PRICE
		(IN.)	(QTY.)		(EA.)
	Tee Bullhead				
 (slip x slip x slip)	401-074	1/2 x 1/2 x 3/4	50	01	1.61
	401-102	3/4 x 3/4 x 1	50	01	2.89
	401-132	1 x 1 x 1 1/4	50	01	3.87
	401-133	1 x 1 x 1 1/2	25	01	5.00
	401-213	1 1/2 x 1 1/2 x 2	25	01	7.02
	401-341	3 x 3 x 4	10	01	36.52

	PART NO.	SIZE	CARTON	CODE	PRICE
		(IN.)	(QTY.)		(EA.)
	Transition Tee				
 (slip x slip x insert)	1102-249	2 x 2 x 1	10	01	4.95

	PART NO.	SIZE	CARTON	CODE	PRICE
		(IN.)	(QTY.)		(EA.)
	Tee				
 (slip x slip x FIPT)	402-005	1/2	50	01	1.01
	402-007	3/4	50	01	1.57
	402-010	1	50	01	2.89
	402-012	1 1/4	25	01	4.61
	402-015	1 1/2	25	01	5.99
	402-020	2	10	01	7.60
	402-030	3	10	01	29.44
	402-040	4	5	01	45.00

	PART NO.	SIZE	CARTON	CODE	PRICE
		(IN.)	(QTY.)		(EA.)
	Tee Reducing (cont.)				
 (slip x slip x FIPT)	402-071	1/2 x 1/2 x 1/8	50	01	2.18
	402-072	1/2 x 1/2 x 1/4	50	01	2.18
	402-074	1/2 x 1/2 x 3/4	50	01	2.18
	402-094	3/4 x 1/2 x 1/2	50	01	1.52
	402-095	3/4 x 1/2 x 3/4	50	01	1.52
	402-101	3/4 x 3/4 x 1/2	50	01	1.34
	402-124	1 x 3/4 x 1/2	50	01	2.89
	402-125	1 x 3/4 x 3/4	50	01	2.89
	402-130	1 x 1 x 1/2	50	01	2.03
	402-131	1 x 1 x 3/4	50	01	2.89

Schedule 40

Tee Reducing (cont.)



(slip x slip x FIPT)

PART NO.	SIZE (IN.)	CARTON (QTY.)	CODE	PRICE (EA.)
402-156	1 1/4 x 1 x 1/2	25	01	4.61
402-157	1 1/4 x 1 x 3/4	25	01	4.61
402-166	1 1/4 x 1 1/4 x 1/2	25	01	4.83
402-167	1 1/4 x 1 1/4 x 3/4	25	01	4.83
402-168	1 1/4 x 1 1/4 x 1	25	01	4.83
402-199	1 1/2 x 1 1/4 x 1/2	25	01	5.99
402-202	1 1/2 x 1 1/4 x 1	25	01	5.99
402-209	1 1/2 x 1 1/2 x 1/2	25	01	5.99
402-210	1 1/2 x 1 1/2 x 3/4	25	01	5.99
402-211	1 1/2 x 1 1/2 x 1	25	01	5.99
402-212	1 1/2 x 1 1/2 x 1 1/4	25	01	5.99
402-239	2 x 1 1/2 x 1	10	01	7.54
402-247	2 x 2 x 1/2	10	01	7.54
402-248	2 x 2 x 3/4	10	01	7.54
402-249	2 x 2 x 1	10	01	7.54
402-250	2 x 2 x 1 1/4	10	01	7.54
402-251	2 x 2 x 1 1/2	10	01	7.54
402-287	2 1/2 x 2 1/2 x 1/2	10	01	16.32
402-288	2 1/2 x 2 1/2 x 3/4	10	01	16.32
402-289	2 1/2 x 2 1/2 x 1	10	01	16.32
402-290	2 1/2 x 2 1/2 x 1 1/4	10	01	16.32
402-291	2 1/2 x 2 1/2 x 1 1/2	10	01	16.32
402-292	2 1/2 x 2 1/2 x 2	10	01	16.32
402-333	3 x 3 x 1/2	10	01	23.33
402-334	3 x 3 x 3/4	10	01	23.33
402-335	3 x 3 x 1	10	01	23.33
402-336	3 x 3 x 1 1/4	10	01	23.33
402-337	3 x 3 x 1 1/2	10	01	23.33
402-338	3 x 3 x 2	10	01	23.33
402-416	4 x 4 x 3/4	4	01	38.96
402-417	4 x 4 x 1	5	01	38.96
402-418	4 x 4 x 1 1/4	5	01	38.96
402-419	4 x 4 x 1 1/2	5	01	38.96
402-420	4 x 4 x 2	5	01	38.96
402-422	4 x 4 x 3	5	01	38.96
402-490	5 x 5 x 4	5	01	101.77
402-528	6 x 6 x 2	5	01	132.05
402-530	6 x 6 x 3	5	01	132.05
402-532	6 x 6 x 4	5	01	132.05

Tee



(slip x FIPT x slip)

PART NO.	SIZE (IN.)	CARTON (QTY.)	CODE	PRICE (EA.)
403-005	1/2	50	01	1.01
403-007	3/4	50	01	1.57

Tee



(FIPT x FIPT x FIPT)

PART NO.	SIZE (IN.)	CARTON (QTY.)	CODE	PRICE (EA.)
405-005	1/2	50	01	2.79
405-007	3/4	50	01	4.38
405-010	1	50	01	6.07
405-012	1 1/4	25	01	8.39
405-015	1 1/2	25	01	8.65

90° ELL



(slip x slip)

PART NO.	SIZE (IN.)	CARTON (QTY.)	CODE	PRICE (EA.)
406-003	3/8	100	01	3.07
406-005	1/2	50	01	0.61
406-007	3/4	50	01	0.69
406-010	1	50	01	1.23
406-012	1 1/4	25	01	2.18
406-015	1 1/2	25	01	2.33
406-020	2	25	01	3.66
406-025	2 1/2	10	01	11.14
406-030	3	10	01	13.33
406-040	4	5	01	23.84
406-050	5	5	01	61.60
406-060	6	4	01	75.79
406-080	8	3	01	195.20

90° ELL Reducing



(slip x slip)

PART NO.	SIZE (IN.)	CARTON (QTY.)	CODE	PRICE (EA.)
406-101	3/4 x 1/2	50	01	1.23
406-130	1 x 1/2	50	01	1.82
406-131	1 x 3/4	50	01	2.19
406-167	1 1/4 x 3/4	25	01	3.49
406-168	1 1/4 x 1	25	01	3.49
406-211	1 1/2 x 1	25	01	5.51
406-212	1 1/2 x 1 1/4	25	01	5.51
406-249	2 x 1	25	01	6.79
406-250	2 x 1 1/4	25	01	6.79
406-251	2 x 1 1/2	25	01	9.40

90° ELL



(FIPT x slip)

PART NO.	SIZE (IN.)	CARTON (QTY.)	CODE	PRICE (EA.)
407-005	1/2	50	01	0.76
407-007	3/4	50	01	0.87
407-010	1	50	01	1.63
407-012	1 1/4	25	01	2.73
407-015	1 1/2	25	01	3.03
407-020	2	10	01	7.83
407-025	2 1/2	10	01	19.35
407-030	3	10	01	29.00
407-040	4	5	01	43.96

90° ELL Reducing



(slip x FIPT)

PART NO.	SIZE (IN.)	CARTON (QTY.)	CODE	PRICE (EA.)
407-074	1/2 x 3/4	50	01	1.63
407-101	3/4 x 1/2	50	01	0.90
407-130	1 x 1/2	50	01	2.51
407-131	1 x 3/4	50	01	2.51
407-168	1 1/4 x 1	25	01	3.66
407-211	1 1/2 x 1	25	01	6.09
407-212	1 1/2 x 1 1/4	25	01	6.32
407-249	2 x 1	25	01	10.51
407-250	2 x 1 1/4	10	01	10.51
407-251	2 x 1 1/2	10	01	10.51

90° ELL





(FIPT x FIPT)

PART NO.	SIZE (IN.)	CARTON (QTY.)	CODE	PRICE (EA.)
408-005	1/2	50	01	1.47
408-007	3/4	50	01	2.19
408-010	1	50	01	4.66
408-012	1 1/4	25	01	4.99
408-015	1 1/2	25	01	6.32
408-020	2	10	01	9.57

Schedule 40

90° Street ELL	PART NO.	SIZE	CARTON	CODE	PRICE
		(IN.)	(QTY.)		(EA.)
	409-005	1/2	50	01	1.72
	409-007	3/4	50	01	2.12
	409-010	1	50	01	3.66
	409-012	1 1/4	25	01	4.38
	409-015	1 1/2	25	01	4.83
	409-020	2	10	01	9.32
	409-025	2 1/2	10	01	16.71
	409-030	3	10	01	20.63

90° Street ELL	PART NO.	SIZE	CARTON	CODE	PRICE
		(IN.)	(QTY.)		(EA.)
	410-005	1/2	50	01	1.34
	410-007	3/4	50	01	1.57
	410-010	1	50	01	2.62
	410-012	1 1/4	25	01	3.66
	410-015	1 1/2	25	01	3.83
	410-020	2	10	01	9.41
	410-101	3/4 x 1/2	50	01	1.91

90° Street ELL	PART NO.	SIZE	CARTON	CODE	PRICE
		(IN.)	(QTY.)		(EA.)
	411-005	1/2	50	01	1.66
	411-007	3/4	50	01	2.00
	411-010	1	50	01	3.51
	411-012	1 1/4	25	01	4.20
	411-015	1 1/2	25	01	4.76

90° Street ELL	PART NO.	SIZE	CARTON	CODE	PRICE
		(IN.)	(QTY.)		(EA.)
	412-005	1/2 PVC	50	01	1.80
	412-007	3/4 PVC	50	01	2.19
	412-010	1 PVC	50	01	3.74
	412-012	1 1/4 PVC	25	01	4.66
	412-015	1 1/2 PVC	25	01	5.06
	M412-005	1/2 Poly*	50	01	1.77
	M412-007	3/4 Poly*	50	01	2.13
	M412-010	1 Poly*	50	01	3.71

Not Listed by NSF*

Side Outlet 90° ELL	PART NO.	SIZE	CARTON	CODE	PRICE
		(IN.)	(QTY.)		(EA.)
	413-005	1/2	50	01	3.32
	413-007	3/4	50	01	4.51
	413-010	1	25	01	5.78
	413-015	1 1/2	25	01	6.34
	413-020	2	10	01	8.80

Side Outlet 90° ELL	PART NO.	SIZE	CARTON	CODE	PRICE
		(IN.)	(QTY.)		(EA.)
	414-005	1/2	50	01	3.23
	414-010	1	25	01	5.79
	414-101	3/4 x 3/4 x 1/2	50	01	4.18
	414-130	1 x 1 x 1/2	25	01	5.47

Reducing ELL	PART NO.	SIZE	CARTON	CODE	PRICE
		(IN.)	(QTY.)		(EA.)
	416-251	2 x 1 1/2 (2 spg)	25	01	9.40
	416-292	2 1/2 x 2 (2 1/2 spg)	10	01	5.38

45° ELL	PART NO.	SIZE	CARTON	CODE	PRICE
		(IN.)	(QTY.)		(EA.)
	417-005	1/2	50	01	1.01
	417-007	3/4	50	01	1.57
	417-010	1	50	01	1.88
	417-012	1 1/4	25	01	2.62
	417-015	1 1/2	25	01	3.29
	417-020	2	25	01	4.28
	417-025	2 1/2	10	01	11.16
	417-030	3	10	01	17.32
	417-040	4	5	01	31.05
	417-050	5	5	01	61.60
	417-060	6	4	01	76.72
	417-080	8	4	01	184.51

45° Street ELL	PART NO.	SIZE	CARTON	PRICE
		(IN.)	(QTY.)	(EA.)
	423-015	1 1/2	25	01 3.29
	423-020	2	25	01 4.28
	423-025	2 1/2	10	01 13.95
	423-030	3	10	01 17.32

22 1/2° ELL	PART NO.	SIZE	CARTON	CODE	PRICE
		(IN.)	(QTY.)		(EA.)
	465-015	1 1/2	20	01	4.23
	465-020	2	10	01	6.11
	465-025	2 1/2	10	01	15.94
	465-030	3	5	01	24.70
	465-040	4	4	01	44.38
	465-060*	6	3	01	109.57

250 p.s.i. working pressure. *200 p.s.i. working pressure.
Does not comply with ASTM D2466

Cross	PART NO.	SIZE	CARTON	CODE	PRICE
		(IN.)	(QTY.)		(EA.)
	420-005	1/2	50	01	2.33
	420-007	3/4	50	01	3.88
	420-010	1	50	01	4.83
	420-012	1 1/4	25	01	6.38
	420-015	1 1/2	25	01	7.23
	420-020	2	10	01	10.67
	420-025	2 1/2	8	01	22.63
	420-030	3	10	01	27.73
	420-040	4	5	01	41.12

Cross Reducing	PART NO.	SIZE	CARTON	CODE	PRICE
		(IN.)	(QTY.)		(EA.)
	420-335	3 x 3 x 1 x 1	10	01	24.24
	420-337	3 x 3 x 1 1/2 x 1 1/2	10	01	24.24
	420-338	3 x 3 x 2 x 2	10	01	24.24
	420-419	4 x 4 x 1 1/2 x 1 1/2	5	01	40.53
	420-420	4 x 4 x 2 x 2	5	01	40.53

Schedule 40

PART NO.	SIZE	CARTON	CODE	PRICE
	(IN.)	(QTY.)		(EA.)
428-015	1 1/2 (*1.825)	25	01	3.04
428-020	2 (*1.945)	25	01	3.80

Long Socket Coupling



(slip)

*Socket depth, each side.
For Nested and Deep Socket Couplings, See page 6.

PART NO.	SIZE	CARTON	CODE	PRICE
	(IN.)	(QTY.)		(EA.)
429-003	3/8	100	01	1.10
429-005	1/2	100	01	0.40
429-007	3/4	50	01	0.55
429-010	1	50	01	0.97
429-012	1 1/4	25	01	1.34
429-015	1 1/2	25	01	1.43
429-020	2	25	01	2.19
429-025	2 1/2	10	01	4.83
429-030	3	10	01	7.56
429-040	4	5	01	10.94
429-050	5	4	01	20.03
429-060	6	5	01	34.59
429-080	8	4	01	64.59

Coupling



(slip)

For Nested and Deep Socket Couplings, See page 6.

PART NO.	SIZE	CARTON	CODE	PRICE
	(IN.)	(QTY.)		(EA.)
429-101	3/4 x 1/2	50	01	1.01
429-131	1 x 3/4	50	01	1.72
429-168	1 1/4 x 1	25	01	2.89
429-212	1 1/2 x 1 1/4	25	01	3.07
429-251	2 x 1 1/2	10	01	4.88
429-338	3 x 2	5	01	26.23
429-422	4 x 3	4	01	32.78
429-532	6 x 4	4	01	43.26
429-582	8 x 4	4	01	100.32
429-585	8 x 6	4	01	110.79

Reducer Coupling



(slip)

Coupling



(FIPT x FIPT)

PART NO.	SIZE	CARTON	CODE	PRICE
	(IN.)	(QTY.)		(EA.)
430-005	1/2	100	01	0.77
430-007	3/4	50	01	1.43
430-010	1	50	01	1.88
430-020	2	25	01	15.07
430-101	3/4 x 1/2	50	01	2.90
430-131	1 x 3/4	50	01	3.19
430-005-45	1/2 Gray	100	01	0.87
430-007-45	3/4 Gray	50	01	1.61
430-101-45	3/4 x 1/2 Gray	50	01	2.90
430-131-45	1 x 3/4 Gray	50	01	3.19

Riser Extender



(MIPT x FIPT)

PART NO.	SIZE	CARTON	CODE	PRICE
	(IN.)	(QTY.)		(EA.)
434-005	1/2 x 2 1/16 lg.	50	01	1.12
434-007	3/4 x 1 5/8 lg.	50	01	1.88
434-008	3/4 x 2 5/16 lg.	50	01	1.93
434-020	2	25	01	4.77

Female Adapter



(slip x FIPT)

PART NO.	SIZE	CARTON	CODE	PRICE
	(IN.)	(QTY.)		(EA.)
435-005	1/2	100	01	0.69
435-007	3/4	50	01	0.87
435-010	1	50	01	1.01
435-012	1 1/4	25	01	1.57
435-015	1 1/2	25	01	1.80
435-020	2	25	01	2.40
435-025	2 1/2	10	01	6.09
435-030	3	10	01	8.17
435-040	4	5	01	13.54
435-050	5	5	01	35.06
435-060	6	4	01	49.82
435-080	8	4	01	93.94

Female Adapter Reducing



(slip x FIPT)

PART NO.	SIZE	CARTON	CODE	PRICE
	(IN.)	(QTY.)		(EA.)
435-074	1/2 x 3/4	50	01	1.23
435-101	3/4 x 1/2	50	01	1.23
435-102	3/4 x 1	50	01	1.63
435-131	1 x 3/4	50	01	1.63
435-211	1 x 1 1/2	25	01	3.29

Male Adapter



(MIPT x slip)

PART NO.	SIZE	CARTON	CODE	PRICE
	(IN.)	(QTY.)		(EA.)
436-005	1/2	100	01	0.55
436-007	3/4	50	01	0.61
436-010	1	50	01	1.10
436-012	1 1/4	25	01	1.34
436-015	1 1/2	25	01	1.80
436-020	2	25	01	2.35
436-025	2 1/2	10	01	6.94
436-030	3	10	01	10.14
436-040	4	5	01	12.93
436-050	5	5	01	21.30
436-060	6	4	01	33.71
436-080	8	4	01	153.21

Male Adapter Reducing



(MIPT x slip)

PART NO.	SIZE	CARTON	CODE	PRICE
	(IN.)	(QTY.)		(EA.)
436-073	1/2 x 3/8	100	01	1.10
436-074	1/2 x 3/4	50	01	1.10
436-101	3/4 x 1/2	50	01	1.01
436-102	3/4 x 1	50	01	1.57
436-131	1 x 3/4	50	01	3.35
436-132	1 x 1 1/4	25	01	3.66
436-133	1 x 1 1/2	25	01	4.12
436-168	1 1/4 x 1	25	01	4.12
436-169	1 1/4 x 1 1/2	25	01	4.12
436-212	1 1/2 x 1 1/4	25	01	4.98
436-213	1 1/2 x 2	10	01	4.98
436-251	2 x 1 1/2	10	01	5.68
436-252	2 x 2 1/2	10	01	8.85
436-253	2 x 3	10	01	9.94
436-293	2 1/2 x 3	10	01	10.70
436-341	3 x 4	10	01	17.12

FIPT	Female Iron Pipe Thread
MIPT	Male Iron Pipe Thread
slip	Solvent Cement Socket
sp	Spigot
T.B.E.	Threaded Both Ends
T.O.E.	Threaded One End
insert	Barbed

Schedule 40

	PART NO.	SIZE	CARTON	CODE	PRICE
		(IN.)	(QTY.)		(EA.)
Reducer Bushing  (sp x slip)	437-073	1/2 x 3/8	100	01	1.17
	437-101	3/4 x 1/2	100	01	0.64
	437-130	1 x 1/2	100	01	1.17
	437-131	1 x 3/4	100	01	1.17
	437-166	1 1/4 x 1/2	25	01	1.57
	437-167	1 1/4 x 3/4	25	01	1.57
	437-168	1 1/4 x 1	25	01	1.57
	437-209	1 1/2 x 1/2	25	01	1.65
	437-210	1 1/2 x 3/4	25	01	1.65
	437-211	1 1/2 x 1	25	01	1.65
	437-212	1 1/2 x 1 1/4	25	01	1.65
	437-247	2 x 1/2	10	01	2.73
	437-248	2 x 3/4	10	01	2.73
	437-249	2 x 1	10	01	2.73
	437-250	2 x 1 1/4	10	01	2.73
	437-251	2 x 1 1/2	25	01	2.73
	437-287	2 1/2 x 1/2	10	01	4.39
	437-288	2 1/2 x 3/4	10	01	4.39
	437-289	2 1/2 x 1	10	01	4.39
	437-290	2 1/2 x 1 1/4	10	01	4.39
	437-291	2 1/2 x 1 1/2	10	01	4.39
	437-292	2 1/2 x 2	10	01	4.39
	437-334*	3 x 3/4	10	01	6.48
	437-335	3 x 1	10	01	6.48
	437-336	3 x 1 1/4	10	01	6.48
	437-337	3 x 1 1/2	10	01	6.48
	437-338	3 x 2	10	01	6.48
	437-339	3 x 2 1/2	10	01	6.48
437-420	4 x 2	5	01	14.47	
437-421	4 x 2 1/2	5	01	14.47	
437-422	4 x 3	5	01	14.47	
437-488	5 x 3	5	01	20.34	
437-490	5 x 4	4	01	20.34	
437-528	6 x 2	5	01	35.81	
437-530	6 x 3	5	01	35.81	
437-532	6 x 4	5	01	35.81	
437-534	6 x 5	5	01	35.81	
437-582	8 x 4	5	01	124.93	
437-585	8 x 6	5	01	124.93	

*Fabricated with Molded Pieces

	PART NO.	SIZE	CARTON	CODE	PRICE
		(IN.)	(QTY.)		(EA.)
Reducer Bushing  (sp x FIPT)	438-071	1/2 x 1/8	100	01	1.34
	438-072	1/2 x 1/4	100	01	1.34
	438-073	1/2 x 3/8	100	01	1.34
	438-098	3/4 x 1/4	50	01	1.34
	438-101	3/4 x 1/2	100	01	1.01
	438-130	1 x 1/2	100	01	1.63
	438-131	1 x 3/4	100	01	1.63
	438-166	1 1/4 x 1/2	25	01	2.51
	438-167	1 1/4 x 3/4	25	01	2.51
	438-168	1 1/4 x 1	25	01	2.51
	438-209	1 1/2 x 1/2	25	01	2.89
	438-210	1 1/2 x 3/4	25	01	2.89
	438-211	1 1/2 x 1	25	01	2.89
	438-212	1 1/2 x 1 1/4	25	01	2.89
	438-247	2 x 1/2	10	01	3.88

	PART NO.	SIZE	CARTON	CODE	PRICE
		(IN.)	(QTY.)		(EA.)
Reducer Bushing  (sp x FIPT)	438-248	2 x 3/4	10	01	3.88
	438-249	2 x 1	10	01	3.88
	438-250	2 x 1 1/4	10	01	3.88
	438-251	2 x 1 1/2	10	01	3.88
	438-288	2 1/2 x 3/4	10	01	4.54
	438-289	2 1/2 x 1	10	01	5.62
	438-290	2 1/2 x 1 1/4	10	01	5.62
	438-291	2 1/2 x 1 1/2	10	01	5.62
	438-292	2 1/2 x 2	10	01	5.62
	438-335	3 x 1	10	01	6.48
	438-336	3 x 1 1/4	10	01	6.48
	438-337	3 x 1 1/2	10	01	6.48
	438-338	3 x 2	10	01	6.48
	438-339	3 x 2 1/2	10	01	6.48
	438-420	4 x 2	5	01	14.44
	438-421	4 x 2 1/2	5	01	14.44
	438-422	4 x 3	5	01	14.44
	438-490	5 x 4	5	01	28.16
	438-528	6 x 2	5	01	47.56
	438-532	6 x 4	5	01	52.86

	PART NO.	SIZE	CARTON	CODE	PRICE
		(IN.)	(QTY.)		(EA.)
Threaded Bushing  (MIPT x FIPT)	439-005	1/2 x 1/2	50	01	1.12
	439-052	3/8 x 1/4	50	01	2.89
	439-072	1/2 x 1/4	50	01	2.89
	439-073	1/2 x 3/8	50	01	2.89
	439-098	3/4 x 1/4	50	01	1.80
	439-099	3/4 x 3/8	50	01	1.80
	439-101	3/4 x 1/2	50	01	1.80
	439-130	1 x 1/2	50	01	2.51
	439-131	1 x 3/4	50	01	2.51
	439-166	1 1/4 x 1/2	25	01	3.73
	439-167	1 1/4 x 3/4	25	01	3.73
	439-168	1 1/4 x 1	25	01	3.73
	439-198	1 1/2 x 2	10	01	5.91
	439-209	1 1/2 x 1/2	25	01	4.51
	439-210	1 1/2 x 3/4	25	01	4.51
	439-211	1 1/2 x 1	25	01	4.51
	439-212	1 1/2 x 1 1/4	25	01	4.51
	439-249	2 x 1	10	01	4.83
	439-250	2 x 1 1/4	10	01	4.83
	439-251	2 x 1 1/2	10	01	4.83
439-292	2 1/2 x 2	10	01	16.88	
439-338	3 x 2	5	01	19.97	

	PART NO.	SIZE	CARTON	CODE	PRICE
		(IN.)	(QTY.)		(EA.)
Cap  (slip)	447-005	1/2	100	01	0.55
	447-007	3/4	100	01	0.64
	447-010	1	50	01	1.01
	447-012	1 1/4	25	01	1.43
	447-015	1 1/2	25	01	1.57
	447-020	2	25	01	1.88
	447-025	2 1/2	10	01	5.99
	447-030	3	10	01	6.55
	447-040	4	5	01	14.89
	447-050	5	5	01	25.00
	447-060	6	5	01	35.69
	447-080	8	4	01	89.66

Schedule 40

Cap	PART NO.	SIZE	CARTON	CODE	PRICE
		(IN.)	(QTY.)		(EA.)
	448-005	1/2	100	01	1.17
	448-007	3/4	100	01	1.34
	448-010	1	50	01	2.03
	448-012	1 1/4	25	01	2.40
	448-015	1 1/2	25	01	2.51
	448-020	2	10	01	4.44
	448-025	2 1/2	10	01	6.55
	448-030	3	10	01	8.56
	448-040	4	5	01	15.03

(FIPT)

Plug	PART NO.	SIZE	CARTON	CODE	PRICE
		(IN.)	(QTY.)		(EA.)
	449-003	3/8	50	01	1.65
	449-005	1/2	50	01	1.34
	449-007	3/4	50	01	1.57
	449-010	1	50	01	1.88
	449-012	1 1/4	25	01	2.51
	449-015	1 1/2	25	01	3.19
	449-020	2	10	01	3.96
	449-025	2 1/2	10	01	6.76
	449-030	3	10	01	8.94
	449-040	4	5	01	20.24

(sp)

Plug	PART NO.	SIZE	CARTON	CODE	PRICE
		(IN.)	(QTY.)		(EA.)
	450-005	1/2	50	01	1.65
	450-007	3/4	50	01	1.78
	450-010	1	50	01	2.89
	450-012	1 1/4	25	01	3.04
	450-015	1 1/2	25	01	3.27
	450-020	2	10	01	4.21
	450-025	2 1/2	10	01	5.86
	450-030	3	10	01	8.87
	450-040	4	5	01	20.02

(MIPT)

Adapter	PART NO.	SIZE	CARTON	CODE	PRICE
		(IN.)	(QTY.)		(EA.)
	474-007	3/4	50	01	2.35
	474-010	1	50	01	2.48
	474-015	1 1/2	25	01	4.38
	474-020	2	25	01	8.11

(insert x slip)

WYE	PART NO.	SIZE	CARTON	CODE	PRICE
		(IN.)	(QTY.)		(EA.)
	475-040	4 x 4 x 4	6	01	125.97
	475-422	4 x 4 x 3	6	01	117.68

150 p.s.i. working pressure.

(slip)

Nested Coupling	PART NO.	SIZE	CARTON	CODE	PRICE
		(IN.)	(QTY.)		(EA.)
	477-005	1/2*	100	01	0.50
	477-007	3/4	50	01	0.55
	477-010	1	50	01	0.97

*1/2" nested couplings do not meet ASTM Standards for Sch. 40 fittings and are not NSF listed.

(slip)

Fitting Adapter	PART NO.	SIZE	CARTON	CODE	PRICE
		(IN.)	(QTY.)		(EA.)
	478-010	1	25	01	*
	478-012	1 1/4	25	01	*
	478-015	1 1/2	25	01	*

(sp x FIPT)

*See Swing Joint Price List: discounts will vary.

Deep Socket Coupling	PART NO.	SIZE	CARTON	CODE	PRICE
		(IN.)	(QTY.)		(EA.)
	482-015	1 1/2 (*2.169)	25	01	3.73
	482-020	2 (*2.389)	25	01	6.18
	482-025	2 1/2 (*3.385)	10	01	7.95
	482-030	3 (*3.625)	10	01	11.98
	482-040	4 (*3.625)	5	01	24.06

*Socket depth, each side.

(slip)

White PVC Union

Union (O-Ring type)	PART NO.	SIZE	CARTON	CODE	PRICE
		(IN.)	(QTY.)		(EA.)
	457-005	1/2	10	01	5.99
	457-007	3/4	10	01	6.81
	457-010	1	10	01	7.02
	457-012	1 1/4	5	01	22.62
	457-015	1 1/2	5	01	23.56
	457-020	2	5	01	31.77
	457-030	3	5	01	71.03

Pressure rated at 150 p.s.i. at 73.4°F.
Unions are listed as NSF 61

(slip x slip)

Union (O-Ring type)	PART NO.	SIZE	CARTON	CODE	PRICE
		(IN.)	(QTY.)		(EA.)
	458-005	1/2	10	01	6.72
	458-007	3/4	10	01	11.22
	458-010	1	10	01	15.30
	458-012	1 1/4	5	01	26.29
	458-015	1 1/2	5	01	26.85
	458-020	2	5	01	33.00
	458-030	3	5	01	75.40
	458-040	4	5	01	100.06

Pressure rated at 150 p.s.i. at 73.4°F.
Unions are listed as NSF 61

(FIPT x FIPT)

Union O-Ring	PART NO.	SIZE	CARTON	CODE	PRICE
		(IN.)	(QTY.)		(EA.)
	40116	1/2	1	01	2.03
	40119	3/4	1	01	2.47
	40119Q	3/4	1	01	1.95
	40123	1	1	01	2.85
	40128	1 1/4	1	01	3.27
	40224	1 1/2	1	01	3.67
	40228	2	1	01	4.10

(Current Style)
Buna-N (Nitrile)

Snap-On Tees	PART NO.	SIZE	CARTON	CODE	PRICE
		(IN.)	(QTY.)		(EA.)
	464-007	3/4	25	01	2.79
	464-101	3/4 x 1/2	25	01	2.35
	464-130	1 x 1/2	50	01	4.22
	464-131	1 x 3/4	25	01	4.22

(Snap-On x FIPT)

Sch 40 Large Diameter-PVC

	PART NO.	SIZE	CARTON	CODE	PRICE
		(IN.)	(QTY.)		(EA.)
TEE	401-100	10	1	91	915.26
	401-120	12	1	91	1352.32



(slip)

	PART NO.	SIZE	CARTON	CODE	PRICE
		(IN.)	(QTY.)		(EA.)
45° ELL, STREET	423-100	10	1	91	606.88
	423-120	12	1	91	889.13



(slip)

	PART NO.	SIZE	CARTON	CODE	PRICE
		(IN.)	(QTY.)		(EA.)
REDUCING TEE	401-624	10 x 10 x 4	1	91	587.61
	401-626	10 x 10 x 6	1	91	723.02
	401-628	10 x 10 x 8	1	91	811.14
	401-664	12 x 12 x 4	1	91	706.14
	401-666	12 x 12 x 6	1	91	806.27
	401-668	12 x 12 x 8	1	91	922.21
	401-670	12 x 12 x 10	1	91	1047.06



(slip)

	PART NO.	SIZE	CARTON	CODE	PRICE
		(IN.)	(QTY.)		(EA.)
COUPLING	429-100	10	1	91	188.24
	429-120	12	1	91	375.05



(slip)

	PART NO.	SIZE	CARTON	CODE	PRICE
		(IN.)	(QTY.)		(EA.)
90° ELL	406-100	10	1	91	735.22
	406-120	12	1	91	986.06



(slip X slip)

	PART NO.	SIZE	CARTON	CODE	PRICE
		(IN.)	(QTY.)		(EA.)
REDUCER COUPLING	429-626	10 x 6	1	91	531.36
	429-628	10 x 8	1	91	531.36
	429-668	12 x 8	1	91	605.03
	429-670	12 x 10	1	91	605.03



(slip)

	PART NO.	SIZE	CARTON	CODE	PRICE
		(IN.)	(QTY.)		(EA.)
90° ELL, STREET	409-100	10	1	91	1095.47
	409-120	12	1	91	1380.48



(slip x sp)

	PART NO.	SIZE	CARTON	CODE	PRICE
		(IN.)	(QTY.)		(EA.)
REDUCER BUSHING	437-623	10 x 3	1	91	374.83
	437-624	10 x 4	1	91	374.83
	437-626	10 x 6	1	91	340.00
	437-628	10 x 8	1	91	340.00
	437-661	12 x 3	1	91	506.29
	437-664	12 x 4	1	91	506.29
	437-666	12 x 6	1	91	506.29
	437-668	12 x 8	1	91	378.12
	437-670	12 x 10	1	91	378.12



(sp x slip)

	PART NO.	SIZE	CARTON	CODE	PRICE
		(IN.)	(QTY.)		(EA.)
45° ELL	417-100	10	1	91	480.32
	417-120	12	1	91	711.78



(slip x sp)

	PART NO.	SIZE	CARTON	CODE	PRICE
		(IN.)	(QTY.)		(EA.)
CAP	447-100	10	1	91	160.26
	447-120	12	1	91	208.04



(slip)

Class 125 Large Diameter-PVC

	PART NO.	SIZE	CARTON	CODE	PRICE
		(IN.)	(QTY.)		(EA.)
TEE	C601-100	10	1	96	336.60
	C601-120	12	1	96	504.90



(slip)

	PART NO.	SIZE	CARTON	CODE	PRICE
		(IN.)	(QTY.)		(EA.)
45° ELL, STREET	C623-100	10	1	96	230.63
	C623-120	12	1	96	337.87



(slip)

	PART NO.	SIZE	CARTON	CODE	PRICE
		(IN.)	(QTY.)		(EA.)
REDUCING TEE	C601-624	10 x 10 x 4	1	96	216.10
	C601-626	10 x 10 x 6	1	96	265.89
	C601-628	10 x 10 x 8	1	96	298.31
	C601-664	12 x 12 x 4	1	96	263.65
	C601-666	12 x 12 x 6	1	96	301.03
	C601-668	12 x 12 x 8	1	96	344.32
	C601-670	12 x 12 x 10	1	96	410.85



(slip)

	PART NO.	SIZE	CARTON	CODE	PRICE
		(IN.)	(QTY.)		(EA.)
COUPLING	C629-100	10	1	96	87.45
	C629-120	12	1	96	140.64



(slip)

	PART NO.	SIZE	CARTON	CODE	PRICE
		(IN.)	(QTY.)		(EA.)
90° ELL	C606-100	10	1	96	282.35
	C606-120	12	1	96	431.85



(slip X slip)

	PART NO.	SIZE	CARTON	CODE	PRICE
		(IN.)	(QTY.)		(EA.)
REDUCER COUPLING	C629-626	10 x 6	1	96	145.80
	C629-628	10 x 8	1	96	90.78
	C629-668	12 x 8	1	96	216.96
	C629-670	12 x 10	1	96	172.70



(slip)

	PART NO.	SIZE	CARTON	CODE	PRICE
		(IN.)	(QTY.)		(EA.)
90° ELL, STREET	C609-100	10	1	96	394.37
	C609-120	12	1	96	496.97



(slip x sp)

	PART NO.	SIZE	CARTON	CODE	PRICE
		(IN.)	(QTY.)		(EA.)
REDUCER BUSHING	C637-623	10 x 3	1	96	362.29
	C637-626	10 x 6	1	96	138.41
	C637-628	10 x 8	1	96	138.41
	C637-661	12 x 3	1	96	489.35
	C637-664	12 x 4	1	96	489.35
	C637-666	12 x 6	1	96	489.35
	C637-668	12 x 8	1	96	249.16
	C637-670	12 x 10	1	96	247.67



(sp x slip)

	PART NO.	SIZE	CARTON	CODE	PRICE
		(IN.)	(QTY.)		(EA.)
45° ELL	C617-100	10	1	96	180.48
	C617-120	12	1	96	264.64



(slip x sp)

	PART NO.	SIZE	CARTON	CODE	PRICE
		(IN.)	(QTY.)		(EA.)
CAP	C647-100	10	1	96	100.65
	C647-120	12	1	96	165.72



(slip)

Pool/Spa Products

PART NO.	SIZE	CARTON	CODE	PRICE
	(IN.)	(QTY.)	(EA.)	
473-825	3/4(1) x 1 x 3/4(1)	50	09	6.90
473-210	1 1/2(2) x 1 1/2 x 3/4(1)	25	09	8.46

Venturi Tee



(Slip x Slip x Spigot)

Note: Bracketed dimensions are OD/Spigot sizes.

PART NO.	SIZE	CARTON	CODE	PRICE
	(IN.)	(QTY.)	(EA.)	
B1640-00	1	50	09	5.20

Wye, Slip



Slip

PART NO.	SIZE	CARTON	CODE	PRICE
	(IN.)	(QTY.)	(EA.)	
B1251-00	2 x 1 1/2	25	09	4.07

Adapter



(MIPT x Red Slip)

PART NO.	SIZE	CARTON	CODE	PRICE
	(IN.)	(QTY.)	(EA.)	
B1221-00	1/2	50	09	1.14
B1231-00	1	50	09	1.39

Plug



(Spigot)

PART NO.	SIZE	CARTON	CODE	PRICE
	(IN.)	(QTY.)	(EA.)	
B1171-00	1 x 1 x 1 1/2	25	09	4.57

Bullhead Tee



(S x S x Spigot)

PART NO.	SIZE	CARTON	CODE	PRICE
	(IN.)	(QTY.)	(EA.)	
SW406015	1 1/2	25	9B	\$7.49
SW406020	2	60	9B	\$9.03
SW406025	2 1/2	30	9B	\$14.39
SW406030	3	20	9B	\$17.23

Sweep Elbow



(Slip x Slip)

PART NO.	SIZE	CARTON	CODE	PRICE
	(IN.)	(QTY.)	(EA.)	
B1241-00	1 1/2	25	09	4.57

90° Elbow



(Spigot x Spigot)

PART NO.	SIZE	CARTON	CODE	PRICE
	(IN.)	(QTY.)	(EA.)	
SW409015	1 1/2	25	9B	\$7.49
SW409020	2	70	9B	\$9.03
SW409025	2 1/2	30	9B	\$14.39
SW409030	3	20	9B	\$17.23

Sweep Elbow



(Slip x Spigot)

- DO NOT USE LASCO FITTINGS FOR COMPRESSED AIR OR GASES.
- DO NOT TEST PVC PIPING SYSTEMS WITH COMPRESSED AIR OR GASES.
- DO NOT USE FITTINGS WITH LIQUIDS NOT RECOMMENDED BY LASCO.
- MODIFICATION OF FITTINGS VOIDS THE WARRANTY.

LASCO Fittings also offers a complete line of valve and insert products commonly used in the Pool and Spa industry.

LASCOfite and UltraFix™

Compression Pressure Fittings

Coupling



PART NO.	SIZE (IN.)	WORKING PRESSURE (@ 73°F)	QUANTITY (CTN)	CODE	PRICE (EA.)
21123	1/2	315	30	14	\$4.46
21124	3/4	315	30	14	\$5.96
21125	1	315	20	14	\$7.72
21126	1 1/4	250	10	14	\$11.77
21127	1 1/2	250	10	14	\$12.01
21128	2	200	10	14	\$15.91
21129	2 1/2	200	8	14	\$29.68
21130	3	150	5	14	\$38.76
21131	4	150	6	14	\$63.83
21133	6	150	4	14	\$117.24

Male Adapter



PART NO.	SIZE (IN.)	WORKING PRESSURE (@ 73°F)	QUANTITY (CTN)	CODE	PRICE (EA.)
21303	1/2	315	30	14	\$3.72
21304	3/4	315	30	14	\$4.16
21305	1	315	20	14	\$5.33
21306	1 1/4	250	10	14	\$8.35
21307	1 1/2	250	10	14	\$9.19
21308	2	200	10	14	\$11.57

UltraFix™



PART NO.	SIZE (IN.)	QUANTITY (CTN)	CODE	PRICE (EA.)
CUF-005	1/2	25	14	\$4.29
CUF-007	3/4	25	14	\$4.80
CUF-010	1	25	14	\$5.65
CUF-012	1 1/4	15	14	\$10.52
CUF-015	1 1/2	15	14	\$11.40
CUF-020	2	12	14	\$17.74
CUF-025	2 1/2	4	14	\$28.52
CUF-030	3	3	14	\$35.68
CUF-040	4	2	14	\$62.40
CUF-060	6	1	14	170.37

Gaskets

PART NO.	SIZE (IN.)	CODE	PRICE (EA.)
22003	1/2	14	\$0.76
22004	3/4	14	\$0.91
22005	1	14	\$1.14
22006	1 1/4	14	\$1.49
22007	1 1/2	14	\$1.78
22008	2	14	\$2.15
22009	2 1/2	14	\$4.10
22010	3	14	\$8.87
22011	4	14	\$15.68
22013	6	14	\$16.23

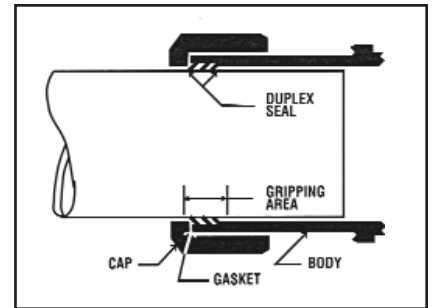

Duplex Seal – Compressive action of thread cap creates high concentrated pressure at two points illustrated. Since cap and body are recessed for compression sealing gasket, no fluid can enter thread cavity of cap.

Gripping Area – Compressive action creates strong gripping action over a wide area of pipe resisting longitudinal pull out.

Repairs or alterations in pipelines are simple with **LASCOfite** fittings. Couplings can be inserted quickly between butted pipe ends. No clearance room is needed – simply slip a coupling all the way over one pipe end, realign the ends, center the coupling and tighten the nuts. New branch lines, test hookups, service joints, or temporary piping can be added easily. The **LASCOfite** fittings can be removed and reused.

No threading or solvent cementing is required. The gaskets provide a positive, leakproof compression seal. **LASCOfite** fittings can be used to join iron pipe size plastic, steel or copper pipe and to attach plastic pipe to threaded valves or fittings.

LASCOfite wall thicknesses meet or exceed those of Schedule 40 fittings as listed in ASTM D-2466.

Specifications: All **LASCOfite** fittings are produced from PVC Type I, Cell Classification 12454-B. **LASCOfite** fittings comply fully with ASTM D-1784 and are listed by NSF.

IMPORTANT:

- Restrain all pipe movement.
- Not to be used above ground.
- Do not use Lasco fittings for compressed air or gas.
- Do not test PVC piping systems with compressed air or gas.
- Do not use fittings with liquids not recommended by Lasco.
- Modifications of fittings voids the warranty.



Headquarters

414 Morgan Street
P.O. Box 116
Brownsville, TN 38012
731/772-3180
800/776-2756
Fax: 731/772-0835

Service Centers

6131 Knott Avenue
Buena Park, CA 90620
714/690-9679
800/995-2726
Fax: 714/736-1780

4780 Holly Street, Unit A
Denver, CO 80216
303/388-7204
888/388-5450
Fax: 303/388-7199

6800 Kingspointe Parkway, Suite 400
Orlando, FL 32819-8588
407/206-5705
800/437-3155
Fax: 407/515-6542

10350 Beaudin Blvd, Suite 600
Woodridge, IL 60517
630/597-0150
888/995-7414
Fax: 630/597-0156

325 Lasley Avenue
Wilkes Barre, PA 18706-1424
570/301-1170
800/882-5462
Fax: 570/301-1176

1600 Kelly Blvd., Suite 130
Carrollton, TX 75006
972/417-0073
800/642-8104
Fax: 972/417-9733

8212 South 228th Street
Kent, WA 98032
425/272-0990
888/285-2726
Fax: 425/272-0995

Limited Warranty

LASCO Fittings, Inc. products are warranted to be free from manufacturing defects in materials and workmanship. They are warranted against rot, rust, and electrolytic corrosion for a period of three years from date of installation. If LASCO products prove defective due to manufacturing defects in material or workmanship during that period, the manufacturer will provide new replacement units of the same type and size. No remedy will be granted under this warranty if LASCO products are not used strictly in accordance with LASCO's directions with respect to use and storage or if the products have been modified in any way. THE MANUFACTURER'S LIABILITY UNDER EXPRESSED OR IMPLIED WARRANTY OR FOR ANY REASON IS LIMITED TO FURNISHING REPLACEMENT UNITS OR GRANTING A CREDIT FOR DEFECTIVE UNITS. NO LABOR EXPENSE OR CONSEQUENTIAL DAMAGES WILL BE PAID BY LASCO. THIS WARRANTY IS IN LIEU OF ALL OTHER GUARANTEES AND WARRANTIES, EXPRESSED OR IMPLIED, INCLUDING BUT NOT LIMITED TO, WARRANTIES OF MERCHANTABILITY AND FITNESS FOR PURPOSE, EXCEPT FOR ANY WARRANTIES IMPLIED BY LAW FOR NONCOMMERCIAL CONSUMERS. ANY SUCH WARRANTIES ARE LIMITED TO THE DURATION OF THIS WRITTEN WARRANTY.

**DO NOT USE LASCO FITTINGS FOR COMPRESSED AIR OR GASES.
DO NOT TEST PVC PIPING SYSTEMS WITH COMPRESSED AIR OR GASES.
DO NOT USE FITTINGS WITH LIQUIDS NOT RECOMMENDED BY LASCO.
MODIFICATIONS OF FITTINGS VOIDS THE WARRANTY.**

STANDARDS AND SPECIFICATIONS – Schedule 40

- ASTM D-1784 – Rigid Poly (Vinyl Chloride) (PVC) Compounds and Chlorinated Poly (Vinyl Chloride) (CPVC) Compounds.
- ASTM D-2466 – Socket Type Poly (Vinyl Chloride) (PVC) Plastic Pipe Fittings, Schedule 40.
- ASTM F-1970 – Standard Specification for Special Engineered Fittings, Appurtenances or Valves for use in Poly (Vinyl Chloride) (PVC) or Chlorinated Poly (Vinyl Chloride) (CPVC) Systems.
- MATERIAL – LASCO Schedule 40 Fittings are produced from PVC Type 1, Cell Classification 12454-B.
- O-rings are produced from a Buna-N (Nitrile) material.
- LISTINGS – NSF/ANSI Standard 61, Annex G: Drinking Water System Components Weighted average lead content of $\leq 0.25\%$ and is in compliance with California's Health & Safety Code Section 116875 (commonly known as AB1953) NSF/ANSI Standard 14: Plastics Piping system Components and Related Materials. Includes /ANSI Standard 61, Annex G

Standard Terms and Conditions of Sale

1. **Terms:** 2% 35 days, net 45 days.
2. **Freight:** FOB LASCO warehouses. Prepaid on orders totaling \$1500 net for one shipment to single destination within the contiguous United States.
3. **Minimum Order:** \$50 net. Smaller orders billed at this minimum charge.
4. **Claims** for shipping errors must be made within 15 days to LASCO. Claims for damage or shortages should be directed promptly to the common carrier by the consignee.
5. **Returns** will be accepted only by prior authorization and if shipped freight prepaid. Returned merchandise subject to a MINIMUM 20% handling/restocking charge.
6. **Pricing** is subject to change without prior notice. However, prior notification will be given in the event of price changes in the period between order placement and scheduled shipment.
7. **Offer** to sell is not implied by possession of this or other LASCO price lists.



Visit our worldwide website
<http://www.lascofittings.com>